

Specifications

MODEL		X555UNS
LCD MODULE		
Viewable Size (Diagonal)	55" / 1,388 mm	
Active Screen Area (W x H)	1,209.6 x 680.4 mm	
Panel Technology	IPS	
Native Resolution	1,920 x 1,080	
Brightness (Factory setting / Maximum)	500 / 700 cd/m ²	
Contrast Ratio (Typical)	1,200:1 (Native contrast)	
Viewing Angle [°]	178 horizontal / 178 vertical (at CR>10)	
Response Time (Typical)	12 ms (G to G)	
Backlight	Direct LED backlight with local dimming	
CONNECTIVITY		
Input Terminals	DisplayPort	DisplayPort x 1
	HDMI	HDMI x 1
	DVI	DVI-D x 1
	VGA	Mini D-sub 15pin x 1
	Audio	Digital: HDMI x 1, DisplayPort x 1, Analogue: 3.5 mm Stereo Mini Jack x 2
Output Terminals	DisplayPort	DisplayPort x 1
	Audio	3.5 mm Stereo Mini Jack x 1
External Control	External Speakers	Speaker terminals for L/R x 1
	RS232C in	D-Sub 9 pin x 1
	Ethernet	RJ-45 10/100BASE-T x 2 (In/out)
Service Port	Remote in	3.5 mm Stereo Mini Jack x 1
Service Port	USB Type A x 1	
Option Slots	Expansion Slots	Open pluggable specification (NEC/Intel OPS standard) x 1. Interface extension x 1
Speaker Output	External Speakers	15 W + 15 W (8 Ω)
POWER		
Power Requirement	4.4 A to 1.6 A @ 100 V to 240 V AC, 50/60 Hz	
Power Consumption (Typical)	205 W @ default	
Power Consumption - standby Mode	<0.5 W	
PHYSICAL SPECIFICATIONS		
Bezel Width	2.3 mm (top and left), 1.2 mm (bottom and right)	
Dimensions (without stand: W x H x D)	1,213.4 x 684.2 x 95.3 mm	
Dimensions (with stand: W x H x D)	1,213.4 x 728.8 x 400.0 mm	
Packaging Dimensions (W x H x D)	1,430 x 863 x 285 mm	
Net Weight (without stand)	29.5 kg	
Gross Weight (with box)	37 kg	
VESA Compatible Mounting Interface	400 x 400 mm (M6, 4 holes)	
Supported Orientation	Landscape, Portrait	
ENVIRONMENTAL CONDITIONS		
Operating Temperature	0°C to 40°C	
Operating Humidity	20% to 80% (without condensation)	
ADDITIONAL FEATURES		
Operating Hours	24/7	
Sensors	Ambient Light Sensor	Integrated, triggered actions programmable
	Motion Sensor	Optional, external, 4-5 m range, triggered actions programmable
	Temperature Sensor	Integrated, 3 sensors, triggered actions programmable
	NFC Sensor	Integrated, 2-cm range, free NEC Android App required
ACCESSORIES		
Included	CD-ROM (User Guides / Manuals), DisplayPort Cable, LAN cable, Power cord, Wireless remote control with batteries, Thumbscrews for optional stand, Clamps, Screws	

Dimensions

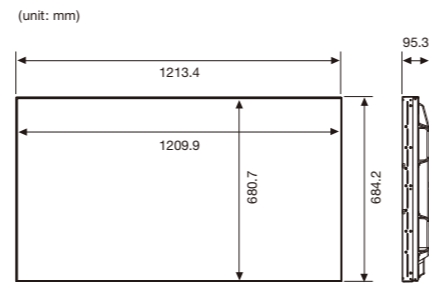

Options

Slot Board



Sensor Kit



Stand



Speaker



Wall Mount Kit

Landscape **WM-55UN-L**
Portrait **WM-55UN-P**



Over Frame Kit

KT-55UN-OF2



Enhance your visual performance with NEC's immaculate ultra-narrow bezel public display.

MultiSync® X555UNS



MultiSync, NavSet, TileMatrix and Frame Comp are trademarks or registered trademarks of NEC Display Solutions, Ltd. in Japan, the United States and other countries. The terms HDMI and HDMI High-Definition Multimedia Interface, and the HDMI Logo are trademarks or registered trademarks of HDMI Licensing LLC in the United States and other countries. DisplayPort and DisplayPort Compliance Logo are trademarks owned by the Video Electronics Standards Association in the United States and other countries. HDBaseT™ and the HDBaseT Alliance logo are trademarks of the HDBaseT Alliance. CRESTRON™ and CRESTRON ROOMVIEW are trademarks or registered trademarks of Crestron Electronics, Inc. AMX is a trademark or registered trademark of AMX in the United States and other countries. Trademark PULink is a trademark applied for trademark rights in Japan, the United States and other countries and areas. VESA is a trademark of a nonprofit organization, Video Electronics Standard Association. All other trademarks are the property of their respective owners. The images in this brochure are samples. All specifications are subject to change without notice. August 2015

The ability to run 24/7 and perfect picture quality make it an ideal solution for retail signage, control room applications, transport installations and rental markets.

An Ultra Narrow Bezel

Mere millimetres separate content from display to display, which ensures a smooth transition across a video wall. The X555UNS minimizes that distance to a ground-breaking 3.5 mm.

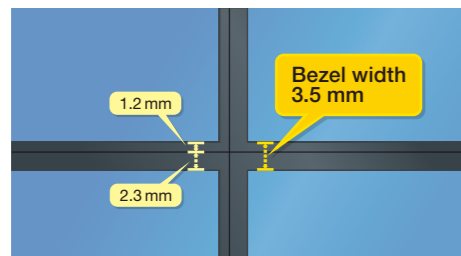

DisplayPort and LAN Control Daisy Chain

Video signals and control signals can be daisy chained with one DisplayPort and LAN line respectively, meaning that just two cables manage everything for setup.

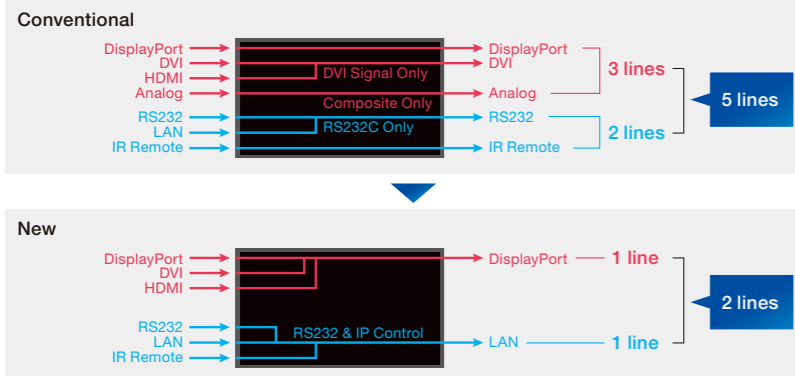

- Just one cable for each video and control
- Just two cables will manage everything
- Up to 100 displays can be daisy chained

Auto TileMatrix and Auto ID Technology

Auto TileMatrix and ID features allow a user to simply set up the size of the video wall on the first display and automatically scale the content through the remaining displays, you can set up an entire video wall (of up to 100 displays in a 10 x 10 matrix).

Intelligent Wireless Data Function

The built-in near field communication (NFC) chip allows data to be read and written via a mobile phone or tablet PC. Users can significantly reduce installation costs as displays can be easily configured and serviced using the NEC NFC Android app.

This is available even when the display is switched off and especially useful on larger installations.



Frame Comp Function

By synchronizing the content across the wall, this feature supports a seamless appearance and displays uninterrupted content to create one stunning image over all screens.

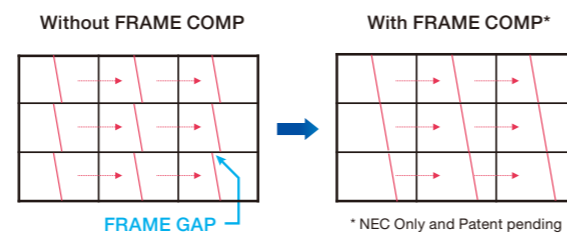

Advanced Heat Management

Monitoring and managing the temperature of each display is crucial to secure reliability and longevity. An industrial-strength, premium-grade panel with additional thermal protection, internal temperature sensors with self-diagnostics, and fan-based technology allows for 24/7 operation, and protects your display investment.



Without heat management, displays placed higher on a wall sustain more heat. However, NEC's advanced heat management ensures uniform heat dissipation.

DisplayPort Multi-stream Function

Thanks to the multi-stream function of DisplayPort, multiple displays can be daisy chained and still be individually controlled. This also makes a 2 x 2 video wall with native Ultra High Definition 4K/2K (3,840 x 2,160) possible.

Human sensor and Advanced Auto Dimming

This new optional human (motion) sensor accessory (KT-RC2) helps to deliver creative digital signage to end users by allowing for dynamic control of brightness, audio and source inputs while saving operating costs. Auto dimming adjusts the backlight of the LCD automatically depending on the amount of ambient light.



No human (motion) detected

- BACKLIGHT : 40
- VOLUME : 30
- INPUT SELECT : DP

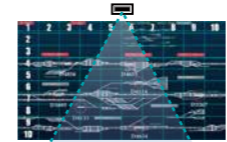

Human (motion) detected

- BACKLIGHT : 60
- VOLUME : 70
- INPUT SELECT : HDMI



Dedicated Colour Calibration Software

As the brightness and colour temperature of the LCD change with time, colours may not match across multiple screens. Our dedicated colour calibration software* ensures colour uniformity and fidelity across multiple screens, creating a perfectly matched image in tiled environments.

* NEC Display Wall Calibrator

Optional Dual Expansion Slots

The dual slot technology allows for the integration of Open Pluggable Specification (OPS*) boards and other option slot products without the need to store additional external equipment. This offers the greater flexibility customers require.

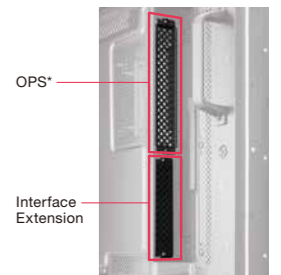

*OPS is a standard established by Intel Corporation.

NaViSet Administrator 2

This software is an all-in-one remote support solution that runs from a central location and provides monitoring, asset management and control functionality of the majority of NEC display devices and Windows computers. It is ideal for multi-device installations over larger infrastructures.



Proof of Play

This function provides accurate proof that displays are working as established and is helpful when checking on the status of the displays installed at user's site.

Other Useful Features and Functions

- Landscape/portrait capability
- Scheduler w/real-time clock
- Intelligent power management system
- Power on delay
- Screen saver function
- Aspect ratio control
- Memo function
- Carbon footprint metre
- Image and on-screen display flip
- Picture-in-picture, Picture-out-picture
- Point zoom
- Control lock function
- 6-axis colour adjustments and sRGB standard
- Advanced video settings (noise reduction, adaptive contrast)
- Colour temperature adjustment
- Programmable gamma setting (3 settings)
- DICOM simulation
- Plug and play (DDC/CI, DDC2B)
- HDCP (High-bandwidth Digital Content Protection)
- Ethernet and RS-232C control and communication
- Crestron RoomView
- AMX Discovery HTTP server
- PLink
- Self-diagnosis
- Status log function
- Firmware update by LAN
- Metal rear cabinet with VESA Standard (FDMIv1) mounting interface
- Handles

Terminals

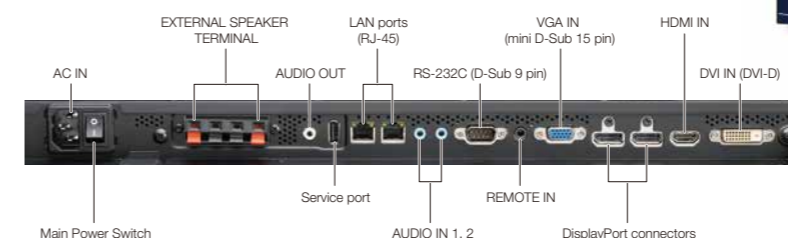

X555UNS